





ST 010 101 3705



- sporgenza 160 mm
- bocca fissa
- Getto squadrato formato da 40 getti singoli
- altezza rubinetteria 108 mm
- altezza fino al rompigitto 94 mm
- diametro foro piletta 32 mm
- diametro foro rubinetteria 35 mm
- 2x tubo flessibile di mandata M 10 x 1 avvitato, tenuta controllata
- portata max 4 l/min
- manopola Ø 60mm
- senza piombo
- Questo prodotto può aiutare un edificio a soddisfare i requisiti dei Green Building Rating Systems, ad es. LEED®, BREEAM®, DGNB

	Dark Platinum spazzolato	ST 010 101 3705-99
	Cromato	ST 010 101 3705-00
	Platinato spazzolato	ST 010 101 3705-06
	Champagne spazzolato (Oro 22k)	ST 010 101 3705-46
	Champagne (Oro 22k)	ST 010 101 3705-47

Componenti singoli di questo set

Per questo set sono necessari i seguenti componenti

1x 13 714 705-99



1x 20 000 740-99



1x 20 000 741-99



ST 010 101 3705



- sporgenza 160 mm
- bocca fissa
- Getto squadrato formato da 40 getti singoli
- altezza rubinetteria 108 mm
- altezza fino al rompigitto 94 mm
- diametro foro 35 mm
- 2x tubo flessibile di mandata M 10 x 1 avvitato, tenuta controllata
- ingresso 1/2"
- portata max 4 l/min
- senza piombo
- Questo prodotto può aiutare un edificio a soddisfare i requisiti dei Green Building Rating Systems, ad es. LEED®, BREEAM®, DGNB

	Dark Platinum spazzolato	13 714 705-99
	Cromato	13 714 705-00
	Platinato spazzolato	13 714 705-06
	Dark Chrome	13 714 705-19
	Champagne spazzolato (Oro 22k)	13 714 705-46
	Champagne (Oro 22k)	13 714 705-47

ST 010 101 3705

mm [inches]



Diagramma di portata



Certificati

GDV_0400279. LGA_28686. IAPMO_N-4976. IAPMO_8834 (1). WRAS_1512011.
 IAPMO_4976 (4). IAPMO_6397.

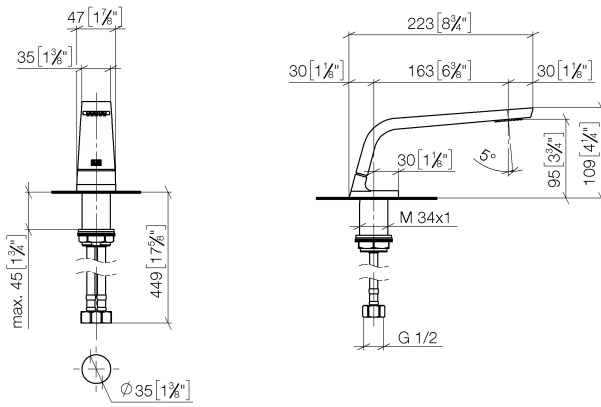
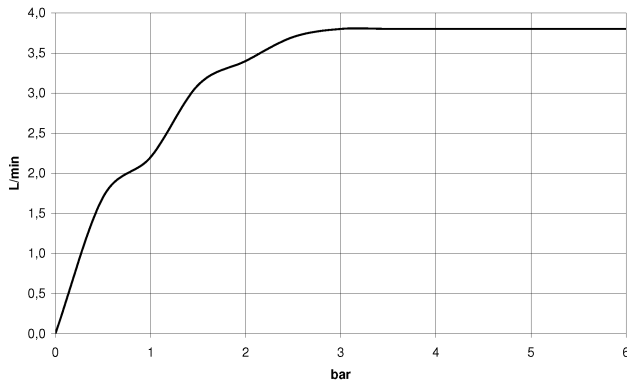
ST 010 101 3705

Parts for other finishes can be found here: Cromato

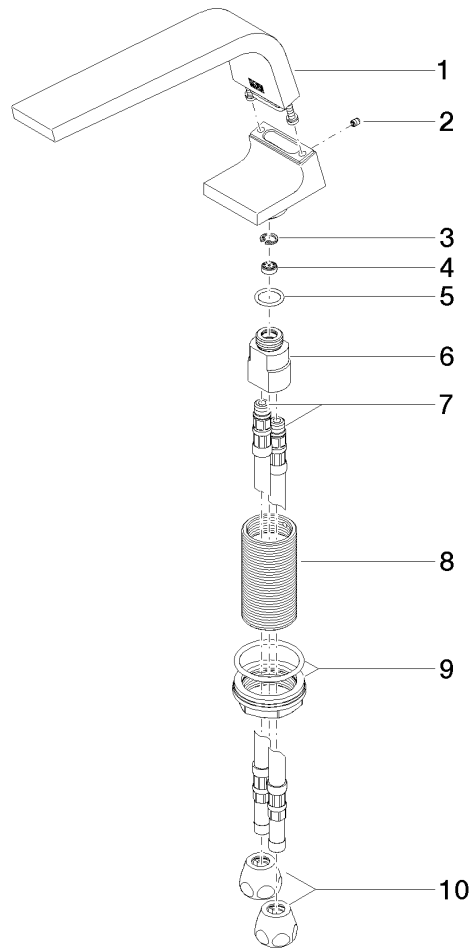

Elenco delle parti di ricambio

N.	Codice articolo	Denominazione	Quantità necessaria	Tempo di produzione
1	90 11 70 002 00-99	bocca di erogazione	1	30
2	09 31 11 044 90	perno	1	2
3	09 16 01 016 90	anello	1	2
4	09 23 01 034 90	limitatore di portata	1	2
5	09 14 10 130 90	guarnizione	1	2
6	09 11 10 055 10 90	attacco	1	2
7	04 30 04 016 00 90	flessibile	2	60
8	09 30 01 208 90	attacco	1	2
9	04 23 10 044 06 90	set di fissaggio	1	2
10	90 23 30 040 00-99	giunto a vite	2	30

ST 010 101 3705

- diametro foro 32 mm
- manopola Ø 60mm
- senza rosetta
- con contrassegno freddo



Compatibile con: CL.1, CYO

	Dark Platinum spazzolato	20 000 740-99
	Cromato	20 000 740-00
	Platinato spazzolato	20 000 740-06
	Platinato	20 000 740-08
	Dark Chrome	20 000 740-19
	Ottone spazzolato (Oro 23k)	20 000 740-28
	Nero opaco	20 000 740-33
	Champagne spazzolato (Oro 22k)	20 000 740-46
	Champagne (Oro 22k)	20 000 740-47

ST 010 101 3705

mm [inches]



Diagramma di portata



Certificati

WRAS_2103001.

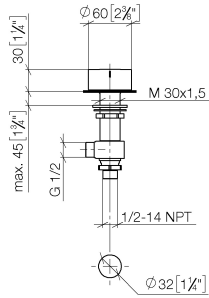
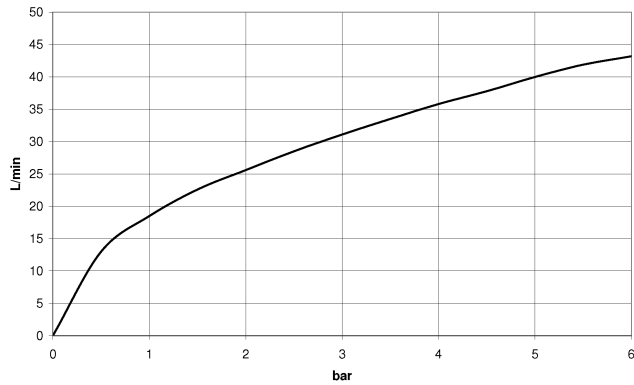
LGA_28688.

IAPMO_4976 (4).

ST 010 101 3705

Parts for other finishes can be found here: Cromato

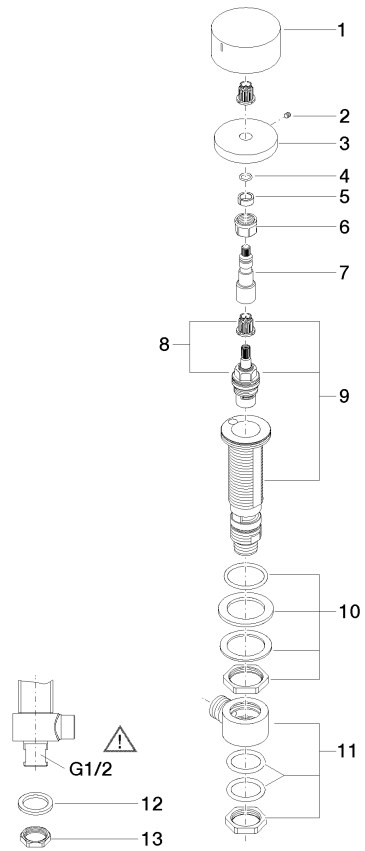

Elenco delle parti di ricambio

N.	Codice articolo	Denominazione	Quantità necessaria	Tempo di produzione
1	09 20 74 005-99	manopola (cold)	1	30
2	90 31 11 007 00 90	perno	1	2
3	09 27 74 003-99	rosetta	1	30
4	90 14 10 060 00 90	guarnizione	1	2
5	90 14 15 020 03 90	anello	1	2
6	90 23 30 023 00 90	dado	1	2
7	09 29 06 107-00	asta filettata	1	10
8	90 90 03 133 00 90	parte superiore	1	2
9	04 17 11 058 33 90	parte laterale	1	2
10	04 23 10 032 78 90	set di fissaggio	1	2
11	04 17 11 023 10 90	distributore	1	2
12	09 30 11 059 90	rondella	1	2
13	09 23 10 012 90	dado	1	2

ST 010 101 3705

- diametro foro 32 mm
- manopola Ø 60mm
- senza rosetta
- con contrassegno caldo



Compatibile con: CL.1, CYO

	Dark Platinum spazzolato	20 000 741-99
	Cromato	20 000 741-00
	Platinato spazzolato	20 000 741-06
	Dark Chrome	20 000 741-19
	Ottone spazzolato (Oro 23k)	20 000 741-28
	Nero opaco	20 000 741-33
	Champagne spazzolato (Oro 22k)	20 000 741-46
	Champagne (Oro 22k)	20 000 741-47

ST 010 101 3705

mm [inches]



Diagramma di portata



Certificati

WRAS_2103001. LGA_28688. IAPMO_4976 (4).

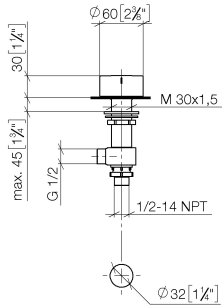
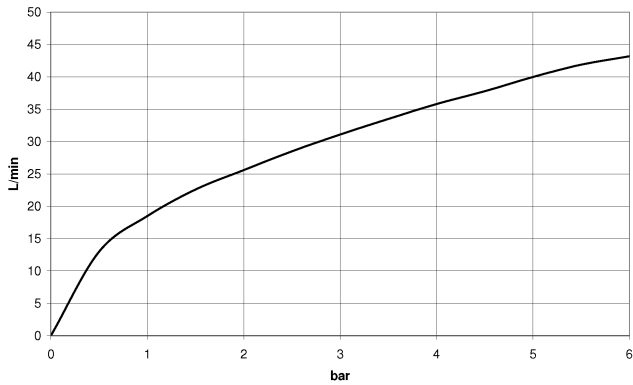
ST 010 101 3705

Parts for other
finishes can be found
here: Cromato

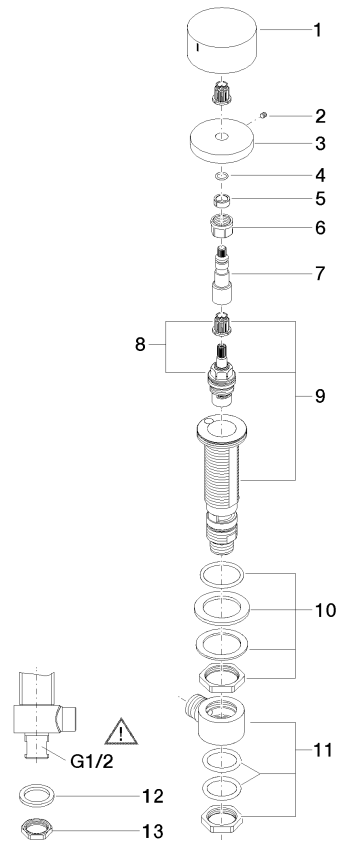

Elenco delle parti di ricambio

N.	Codice articolo	Denominazione	Quantità necessaria	Tempo di produzione
1	09 20 74 006-99	manopola (hot)	1	30
2	90 31 11 007 00 90	perno	1	2
3	09 27 74 003-99	rosetta	1	30
4	90 14 10 060 00 90	guarnizione	1	2
5	90 14 15 020 03 90	anello	1	2
6	90 23 30 023 00 90	dado	1	2
7	09 29 06 107-00	asta filettata	1	10
8	90 90 03 132 00 90	parte superiore	1	2
9	04 17 11 058 32 90	parte laterale	1	2
10	04 23 10 032 78 90	set di fissaggio	1	2
11	04 17 11 023 10 90	distributore	1	2
12	09 30 11 059 90	rondella	1	2
13	09 23 10 012 90	dado	1	2